

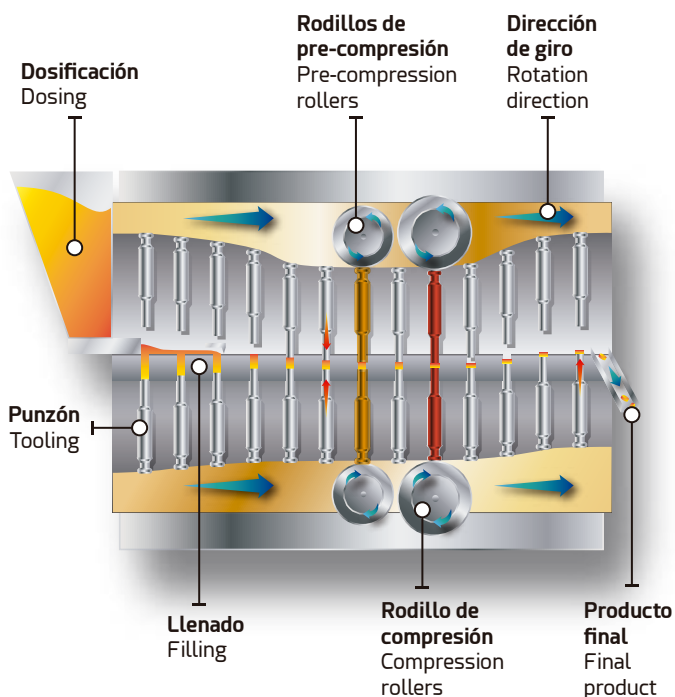



Comprimidora rotativa Rotary tablet press

Kompressor 300 es una comprimidora rotativa con diseño robusto, desarrollada bajo un concepto innovador que permite de forma ágil y segura, cambiar de formatos y/o productos. Está preparada para trabajar con matricería EU o TSM, según las necesidades del cliente.

Kompressor 300 is a rotary tablet press with robust design, developed under an innovative concept that allows you to change formats and/or products quickly and safely. It is prepared to work with EU or TSM tooling, according to the client's needs.



-  **Forzador de carga Sistema Flex Load**
Flex Load System loading forcer
-  **Cabezal intercambiable**
Interchangeable turret head
-  **Sistema de aspiración de polvos**
Dust suction system
-  **Panel touch screen**
Touch screen panel
-  **Control de peso y descarte de comprimidos**
Weight control and discard of tablets
-  **100% servo motorizado ***
100% servo motorized *
-  **Canal de descarga de 3 vías**
3 rows discharge chute
-  **Apto para matricería estándar EU / TSM**
Compatible with EU / TSM standard tooling
-  **FAT/SAT/IQ/OQ Documentación para validación**
FAT/SAT/IQ/OQ Validation documents
-  **Capacitación en Proceso con Producto. Inversión garantizada**
Training in Process with Product. Guaranteed Investment

(*) Item opcional / optional

Comprimidora rotativa

Rotary tablet press

Kompressor 300



Gran producción de tabletas comprimidas
Compressed tablets big batch production

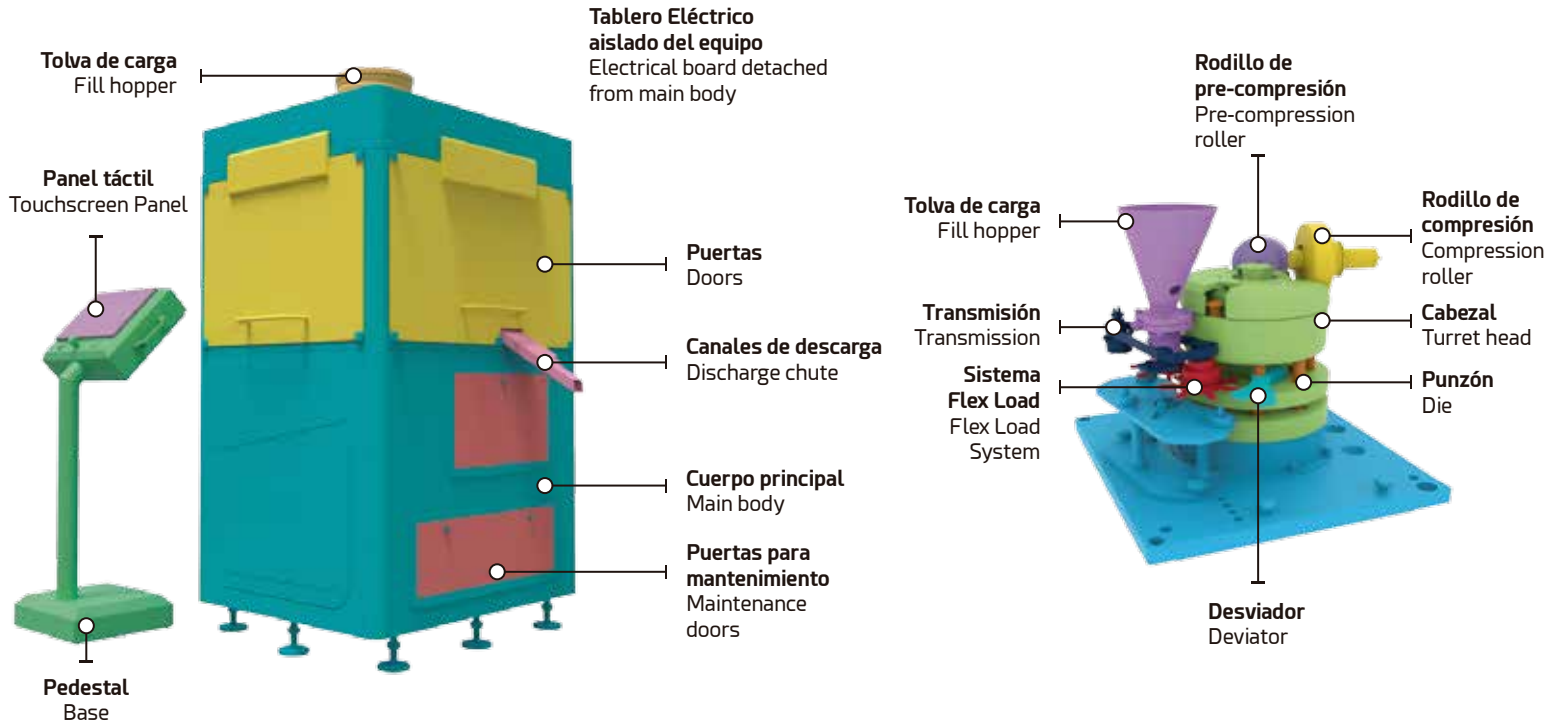

Forzador de carga sistema Flex Load
Flex Load system loadforcer



Cabezal intercambiable
Interchangeable turret head



Sistema de extracción de cabezal
Turret head removal system



Operación desde panel touchscreen
Operation from touchscreen panel



Sistema de aspiración de polvos
Powder suction system



Canal de descarte de 3 vías
3 rows discharge chute

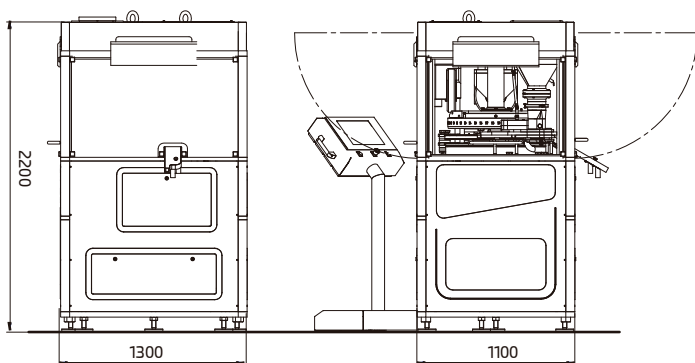

	Unidades Units	D	B	BB
Número de estaciones Number of stations		35	50	60
Diámetro max. de tabletas Max. tablet diameter	mm	25	16	13
Producción máxima Max. production	Tabletas x hora	189.000	300.000	360.000
Fuerza max. de pre-compresión Max. pre-compression force	kN	100	100	100
Fuerza max. de compresión Max. compression force	kN	100	100	100
Velocidad max. de cabezal Max. die plate speed	rpm	20-90	20-100	20-100
Peso aproximado Approximate weight	Kg	6000		

PATGROUP se reserva el derecho de introducir en sus maquinarias, en cualquier momento y sin previo aviso las eventuales modificaciones, detalles o suministro de accesorios, que considere conveniente para el mejoramiento constructivo o comercial.
PATGROUP reserves the right to introduce in its machinery, at any time and without prior notice, any modifications, details or supply of accessories, which it deems appropriate for constructive or commercial improvement.



www.PATGROUP-SA.COM
ESPAÑA | BRASIL | ARGENTINA



europa@patgroup-sa.com